

DC FH9'89'G9FJ ⇒ 9'9B 'DC @W<HM&B9'GD% \$

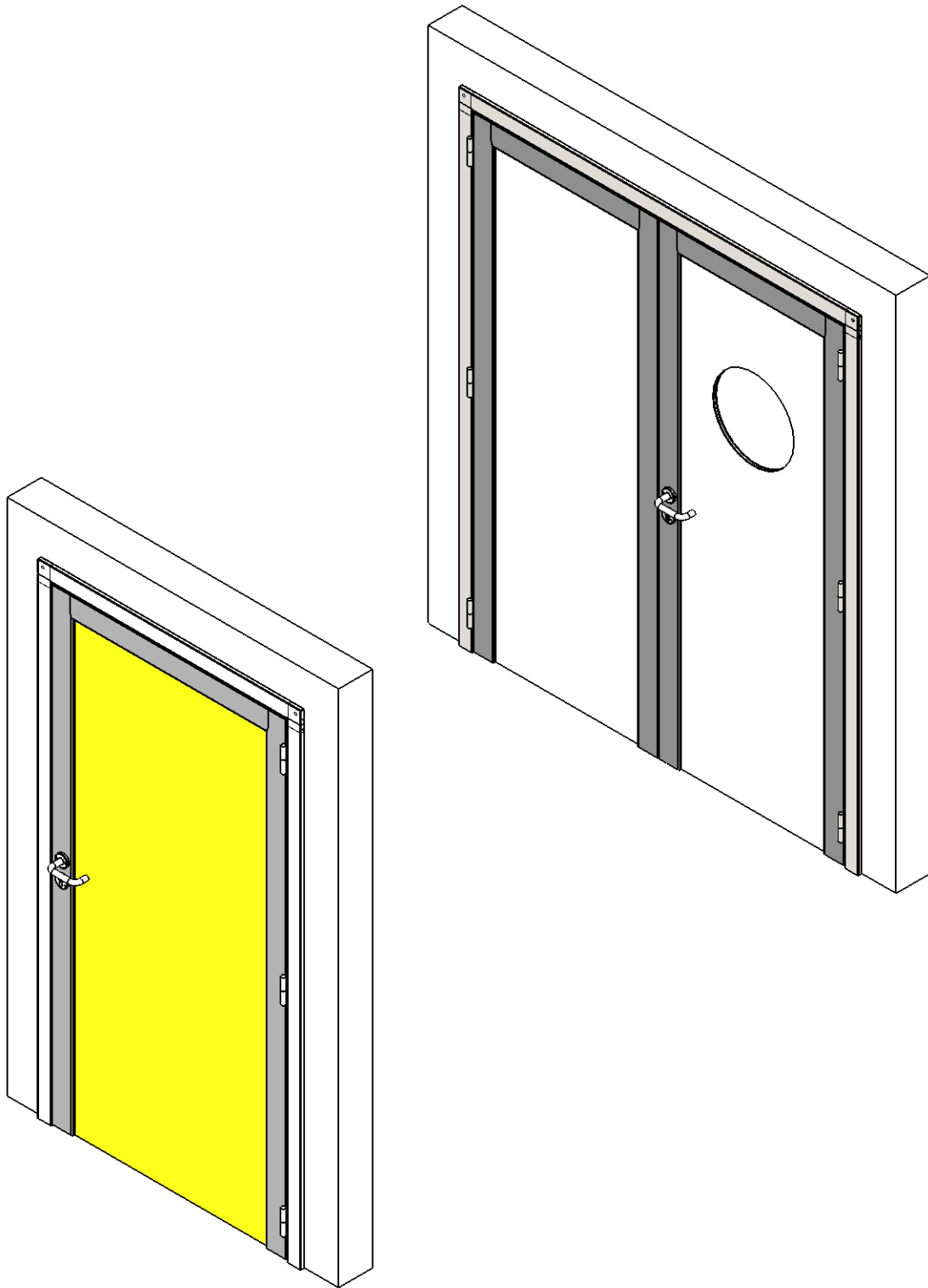

HndY 'Dc ffY'.

GD% \$

<I €G9F ⇒' B C L

9B '@

SPENLE 

: !) + (\$ \$ G5FF96C I F ;
Hf "Z' ' ' ' ' + &) + , '\$ \$
: UI "Z' ' ' ' ' + &) + \$) +

HfUbh8fcjh
Dci ggUbh; Ui WXY

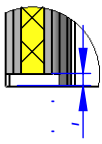
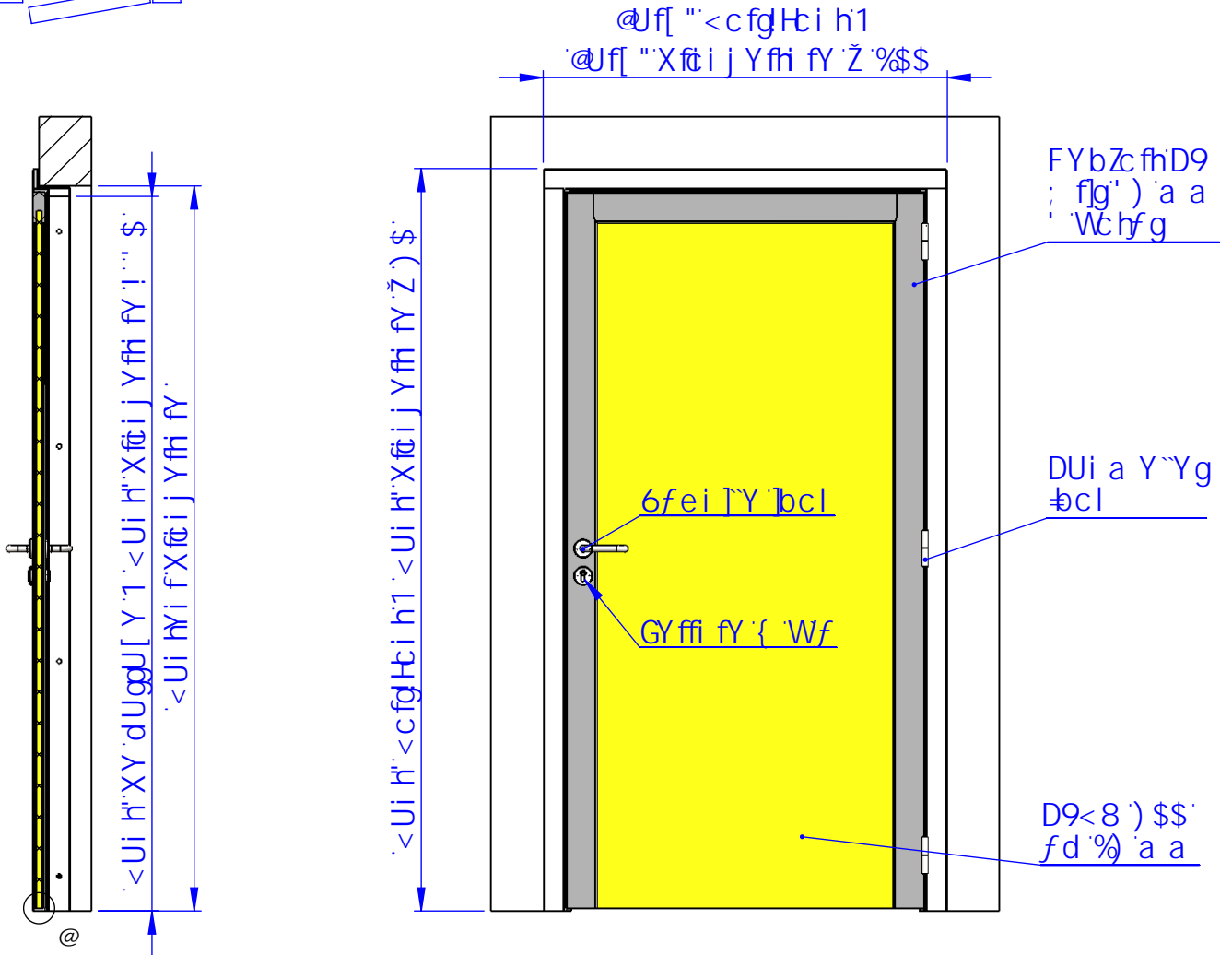

<i jggY fy` @

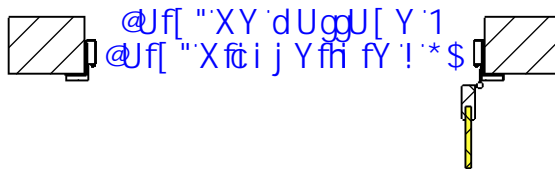
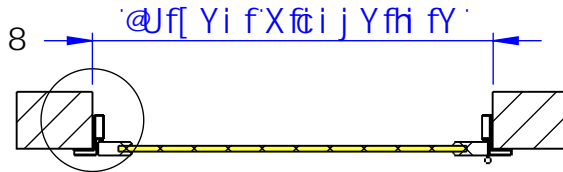
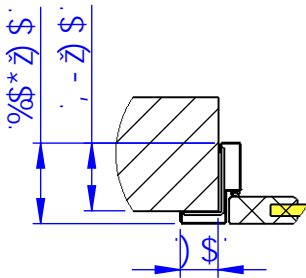

HndY`Dc ffY`.

GD% \$

<I €G9F 9` B C L

9B` @

SPENLE

: !)+(\$\$G5FF96C I F;
Hf`Z`' ; +&) +` \$\$
: UI`Z`' ; +&) +\$) +

HfUbh8 fc]hflj UbhU] 'd flj bWdUŁ
 Dci ggUbh; Ui WXY

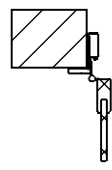
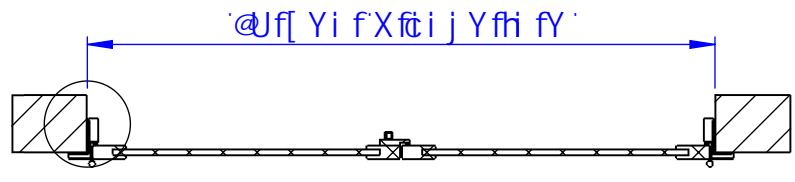
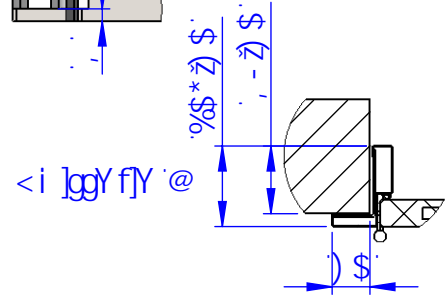
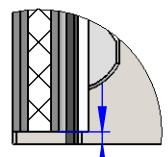
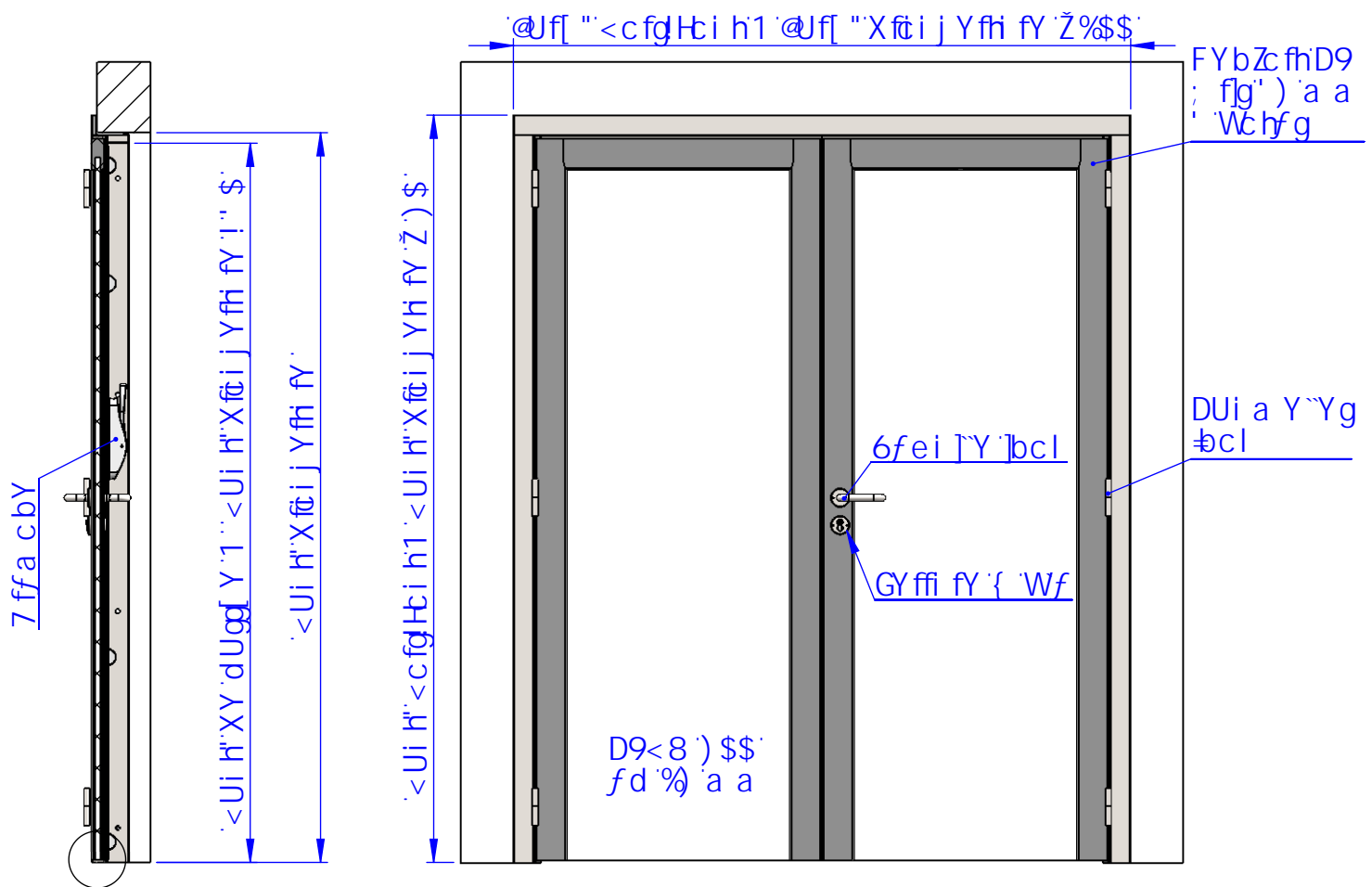
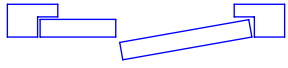

@fl["'XY'dUggU[Y'1
 @fl["'Xfc i j Yfhi fy'!' *\$

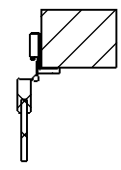

<p>HndY 'Dc ffY'.</p> <p>GD% \$</p>	<p><I €G9F 9' B C L</p> <p>9B '@</p>	<p>SPENLE </p> <p>: !) + (\$\$ G5FF96C I F ; Hf "'Z' ' ' ' ' + &) + ' '\$\$: UI "Z' ' ' ' ' + &) + \$) +</p>
-------------------------------------	---	--